



**ACE  
INTERNATIONAL**



# MODULAR BUILDINGS

**THERMALLY EFFICIENT • BEAUTIFUL • RELIABLE • SAFE**

# MODULAR BUILDINGS

## CONTAINER UNIT

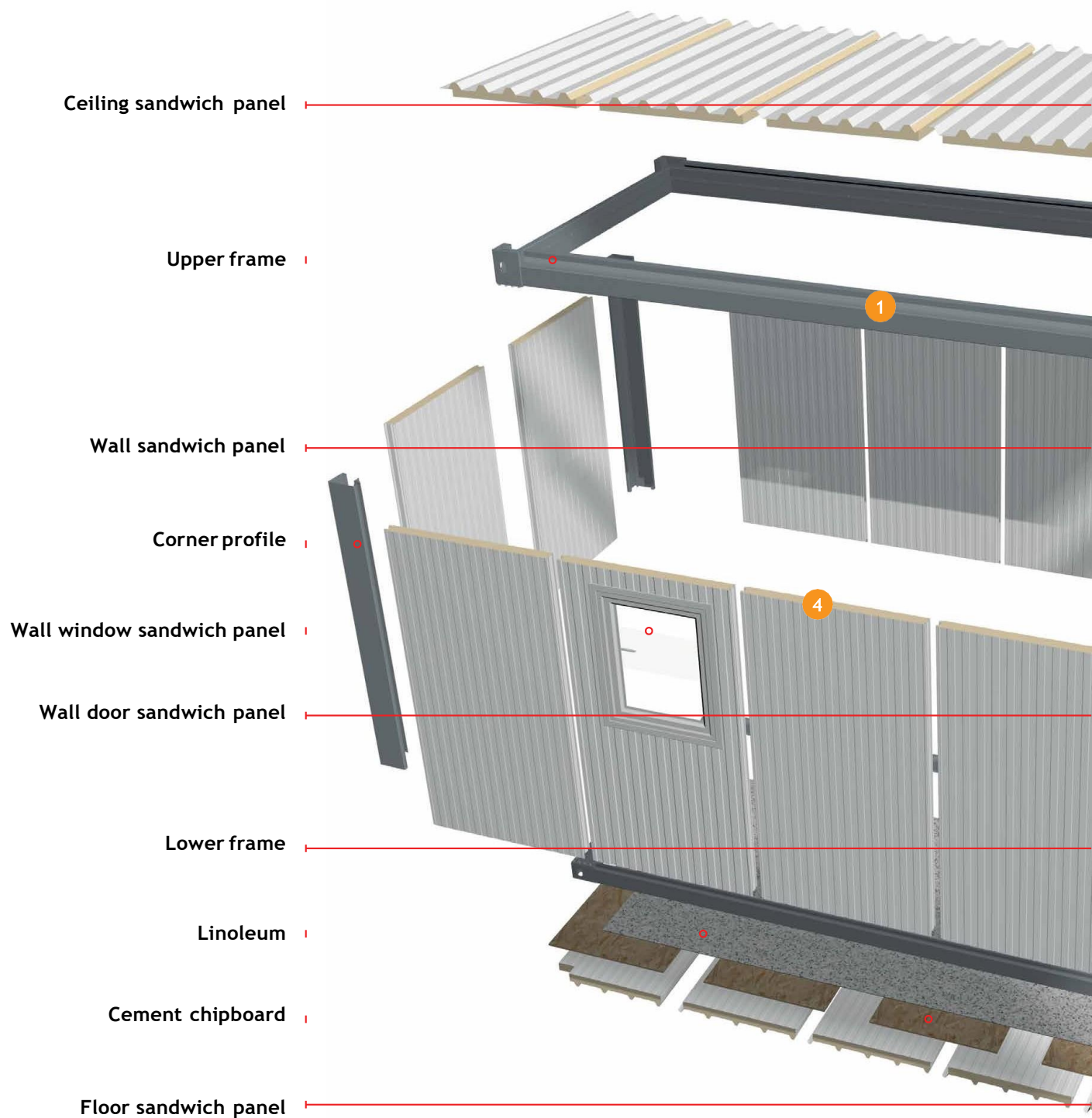

### Sizes

Length, mm	Width, mm	Height, mm
2060	2435	2591–3500
4880	2435	2591–3500
6055	2435	2591–3500
7325	2435	2591–3500
9120	2435	2591–3500

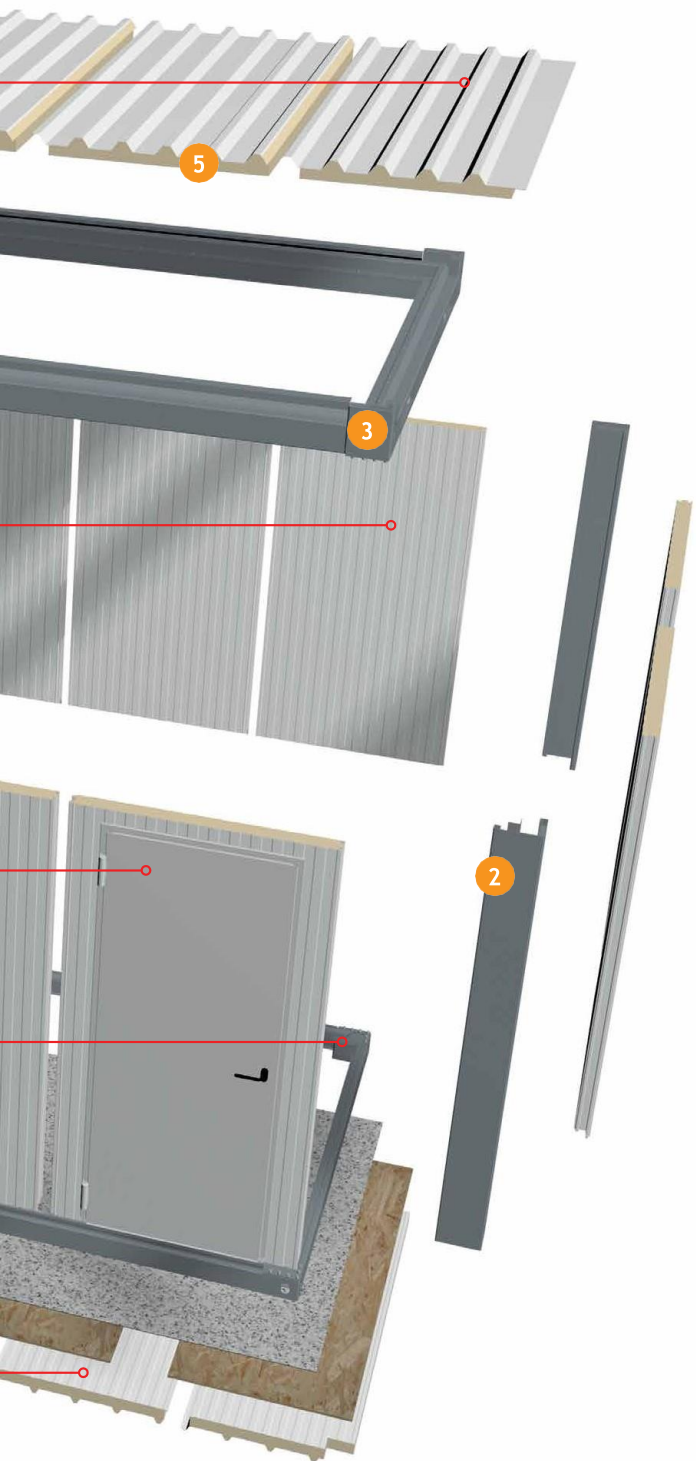

1 Special design of the frame profile has a high load-bearing capacity

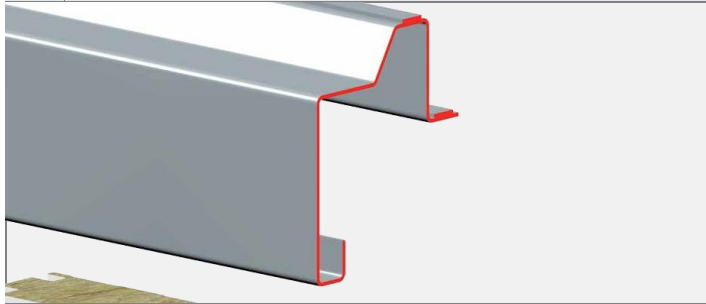

2 Design of the corner profiles allows to erect buildings up to three floors



3 Angle piece of the frame provides a releasable connection

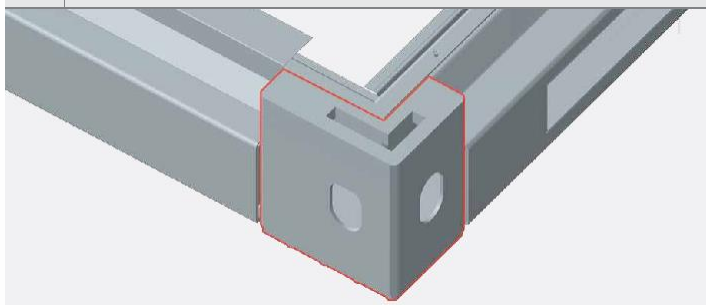

4 Sandwich panels are produced on modern automatic lines

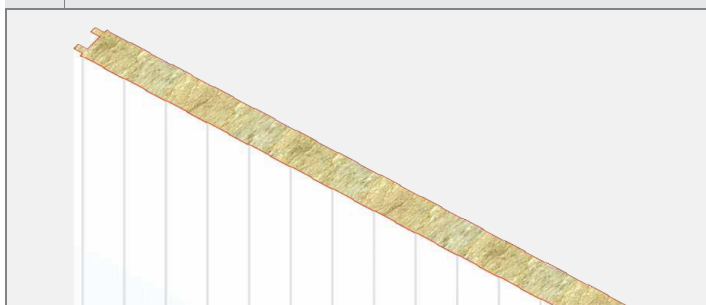

5 Roof panels (ceiling and floor) have a high bearing capacity

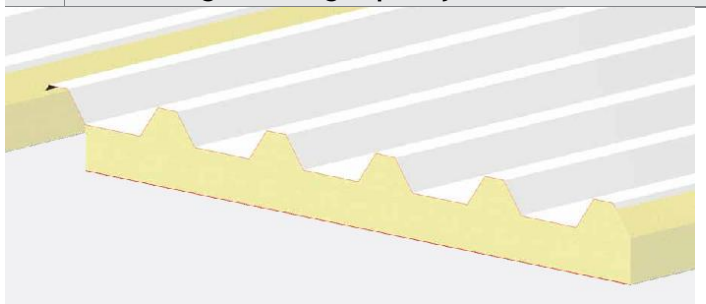

# CONTAINER UNIT



EXAMPLE OF LAYOUT

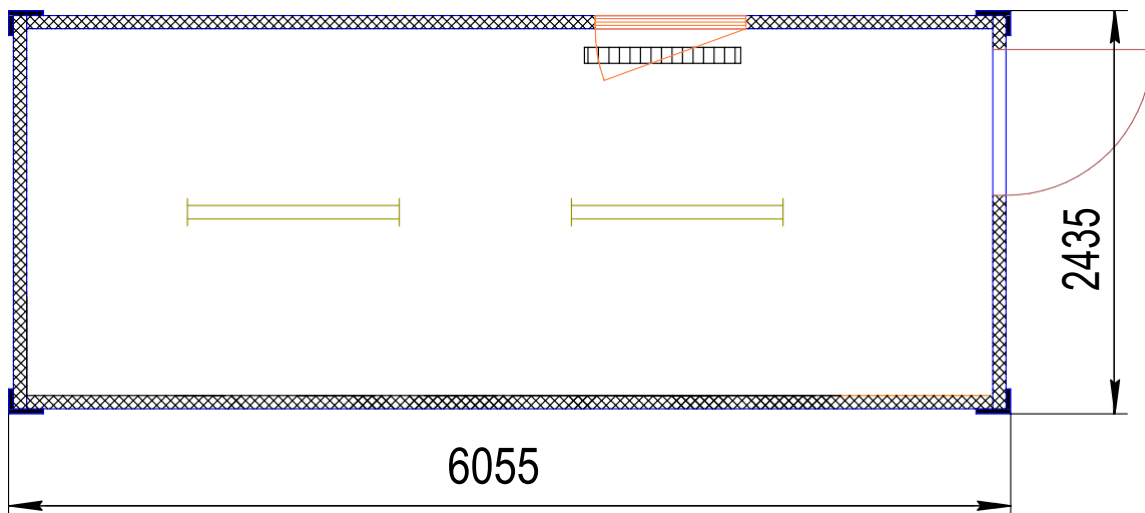

## WIDE SCOPE OF APPLICATION

Optimal for quick construction of the administrative and accommodation buildings. It can be used as the separate structure or as the base unit for construction of larger facilities.

## UNLIMITED POSSIBILITIES

Various combinations of the container units allow to construct the building with the required architectural shapes and any type of interior layout.

# SECURITY POST



EXAMPLE OF LAYOUT

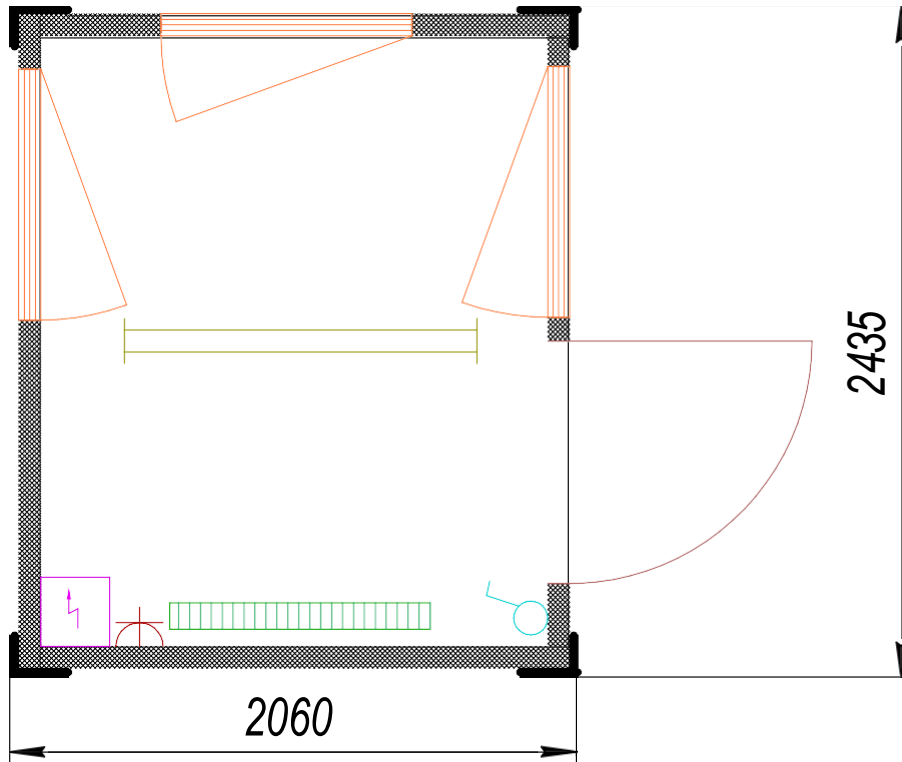

## WIDE USE

Area-saving of the security post provides its installation at the facilities where there is no enough space for erection of larger checkpoints, for example, at the parking lots.

## CONVENIENT OPERATION

The dimensions of the security post envisages the installation of equipment required for convenient service of the employees.

# ADMINISTRATION AND AMENITY BLOCKS



## EXAMPLE OF LAYOUT

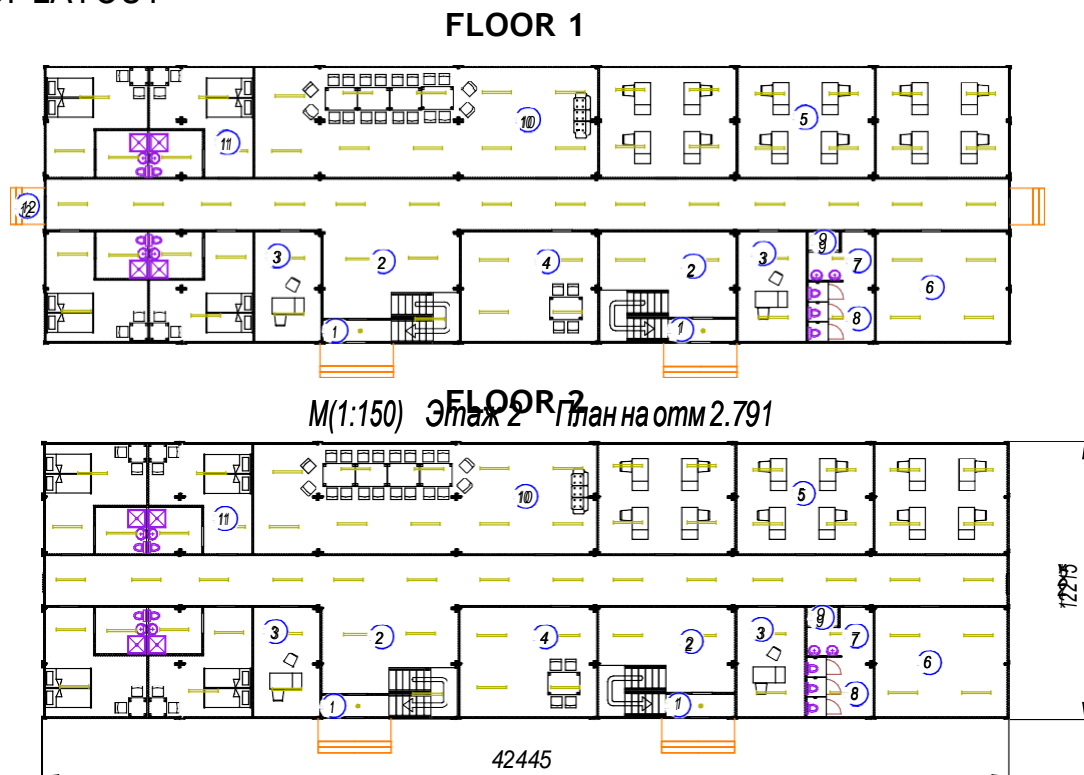

### MULTIPLE LAYOUT OPTIONS

Various configurations of the container units enables to construct the buildings with any number of floors, with any architecture, and interior.

### MINIMUM CONSTRUCTION TIME

Administration and amenity blocks based on the ACE container units are intended to arrange the comfortable working conditions for the employees quickly.

# CONTROL ROOMS



## EXAMPLE OF LAYOUT

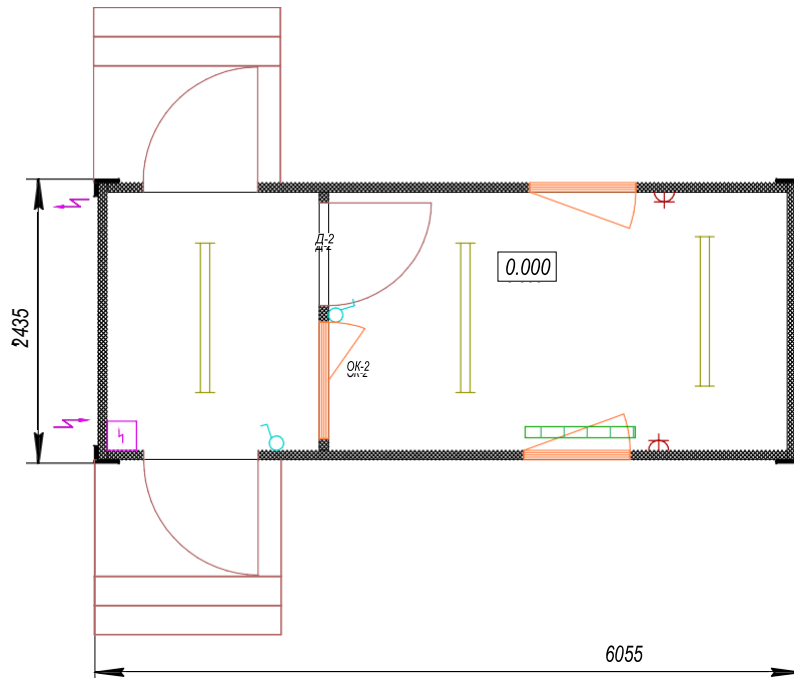

### VARIETY OF STRUCTURES

The control rooms can have various structures and layout depending on the number of the constituent container units.

### HIGH LEVEL OF COMFORT

Comfortable accommodation of the duty attendants in the control room built from “warm” container units is possible in any season.

# DORMITORIES



## EXAMPLE OF LAYOUT

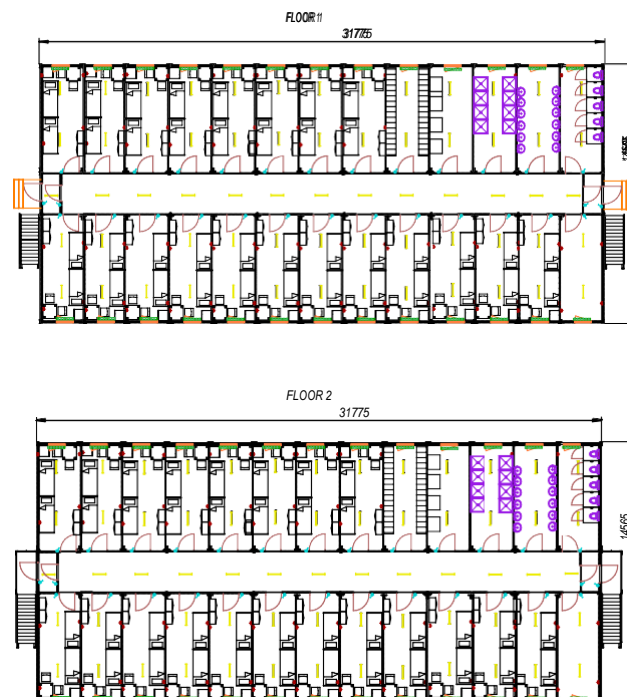

### MULTI-FUNCTIONAL

The dormitories are used in the regions far away from the managing companies to provide the accommodation for the employees. This is especially topical for the organisations engaged in construction, gas production, oil refining, and others

### QUICK CONSTRUCTION

These dormitories are intended for quick construction of the accommodation buildings when it is necessary to ensure comfortable living for the employees as quickly as possible.



# MEDICAL AND OBSTETRICAL STATION



## EXAMPLE OF LAYOUT

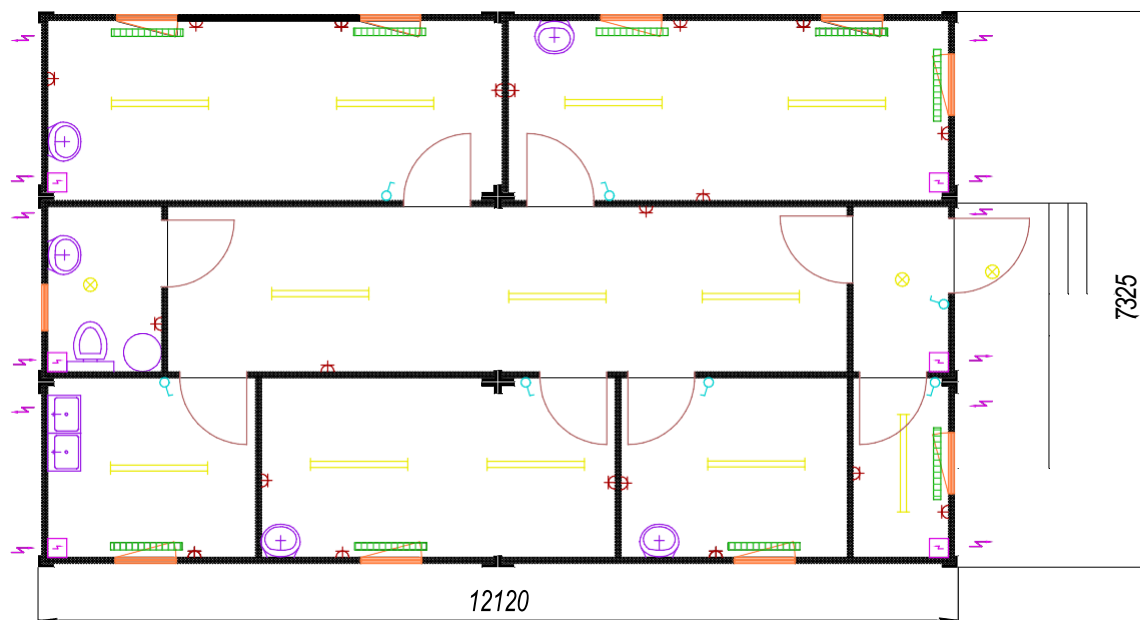

### PERFECT WORK CONDITIONS

Clean and warm premises based on the ACE container units ensure all necessary conditions for normal operation of the medical and obstetrical station.

### MOBILITY

Medical and obstetrical station is intended to provide a workplace for the medical personnel in the rural areas far away from the healthcare institutions.

# MESS HALLS



## EXAMPLE OF LAYOUT

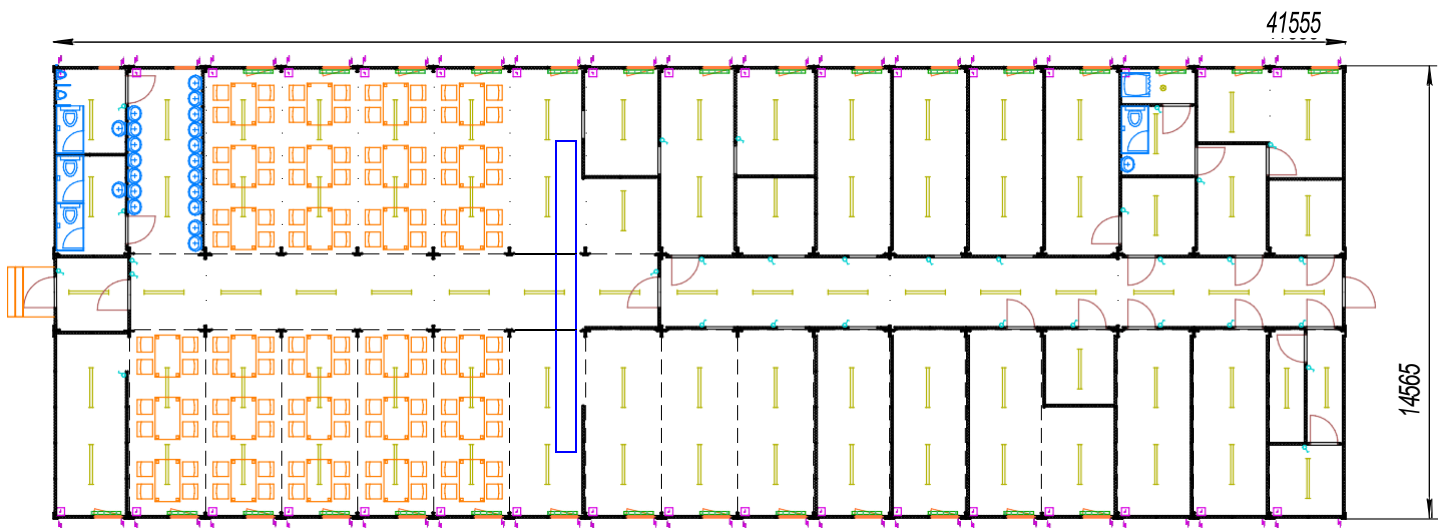

### SAFE OPERATION

The container units made of green materials comply with the sanitary regulations and can be used for the new mess halls construction.

### POSSIBILITY TO USE ANY EQUIPMENT

The mess halls can be equipped with the necessary premises and equipment for the meals cooking, warming, and for enjoying your meals.

# OFFICES, CENTERS



EXAMPLE OF LAYOUT

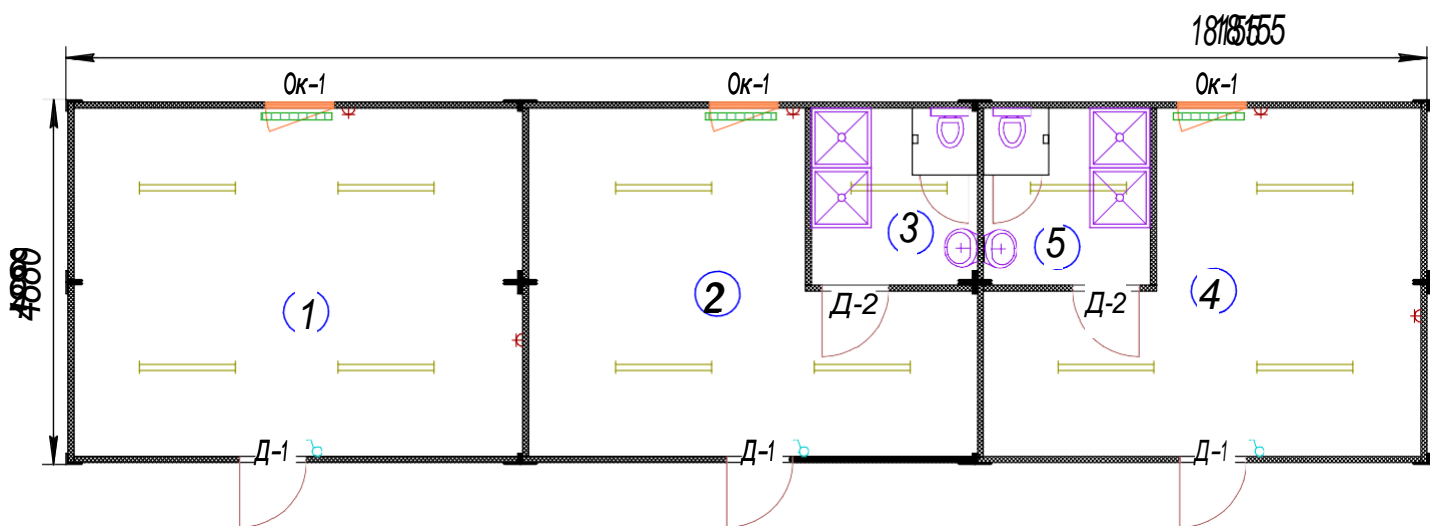

## AESTHETIC APPEARANCE

Accurate look of the container units and the variety of the design of panels used for the container units allow to arrange even the presentable sales offices.

## VARIETY OF APPLICATION

The ACE container units allow to arrange the comfortable premises for the managers and the technical personnel, offices and centers an any construction sites.

# HOTELS



## EXAMPLE OF LAYOUT

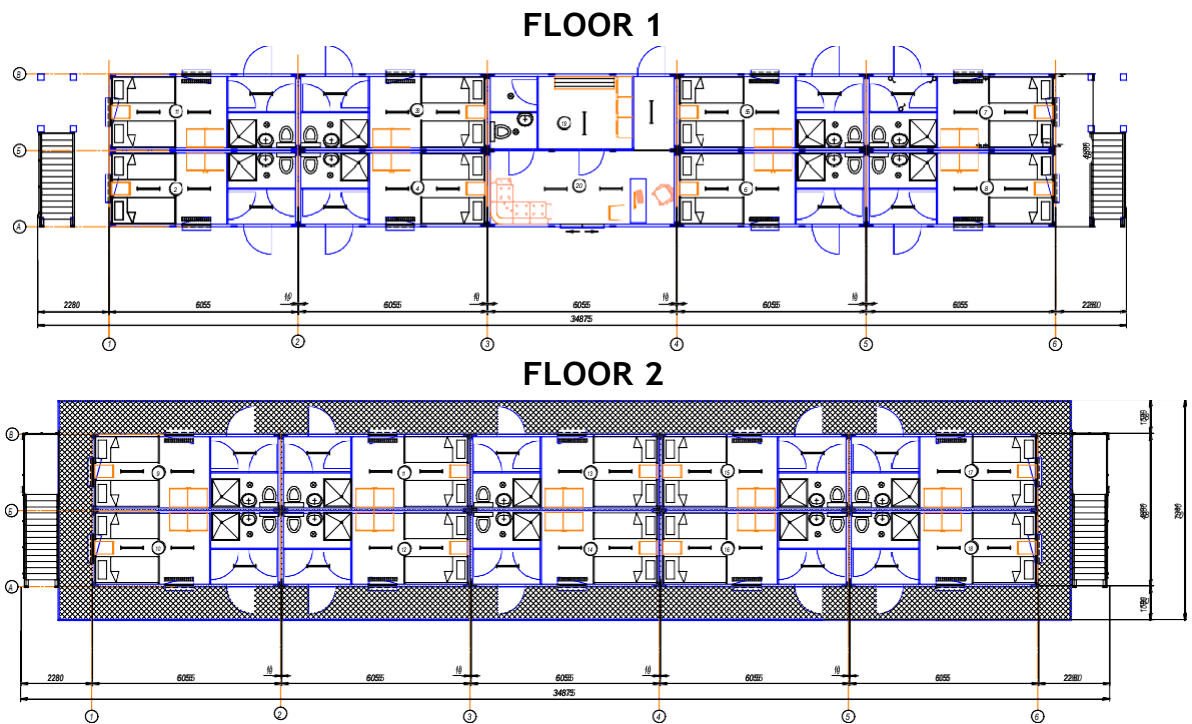

### GOOD DEAL

Quickly erectable hotels made of container units will be the good deal for the recreation centers, campings, fisheries, and hunting.

### HIGH CAPACITY

The hotels can be designed for various flow of visitors depending on the layout and the number of the container units.

# SANITARY CONTAINER UNITS (SHOWER ROOMS, TOILET ROOMS)



EXAMPLE OF LAYOUT

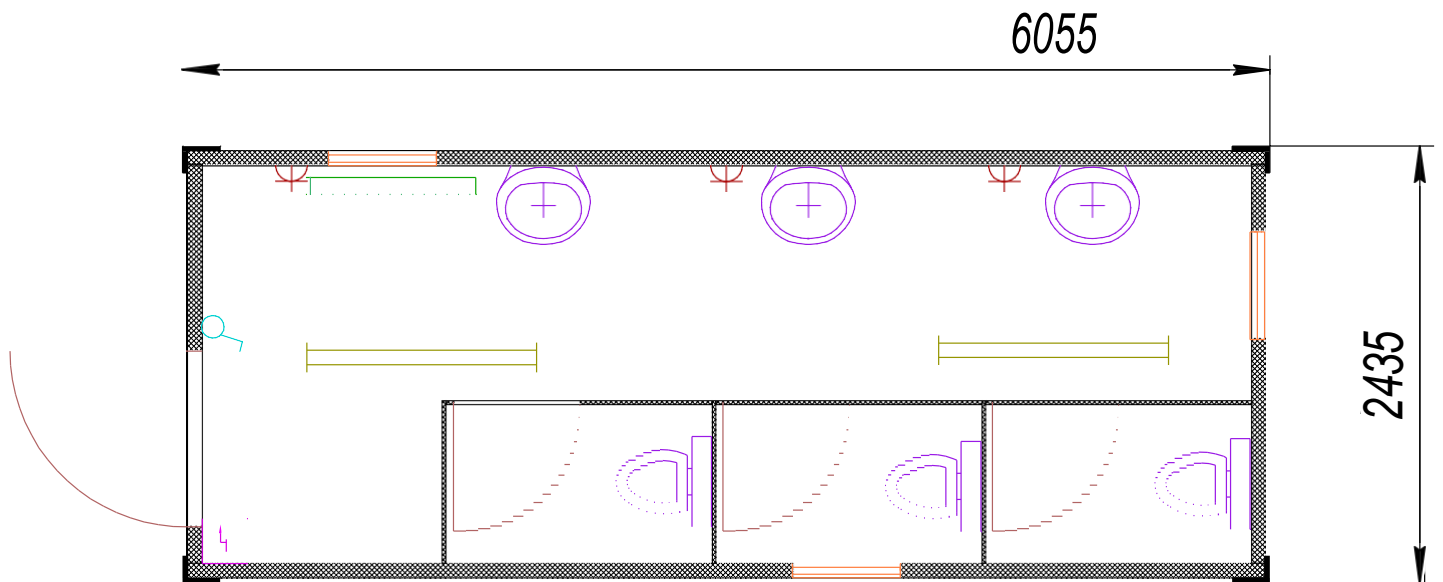

## CONVENIENT OPERATION

ACE container units for the sanitary facilities ensure the most comfortable conditions in any season.

## WIDE POSSIBILITIES

The container units can also serve to arrange the WCs in the buildings, as well as to arrange the stand-alone shower rooms and toilet rooms.

# PAVILIONS, CAFES, AND OTHER FACILITIES FOR THE SMALL-SIZE AND MIDDLE-SIZE BUSINESS



EXAMPLE OF LAYOUT

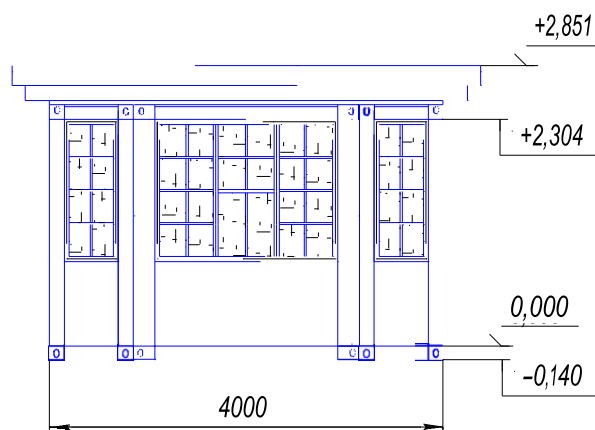
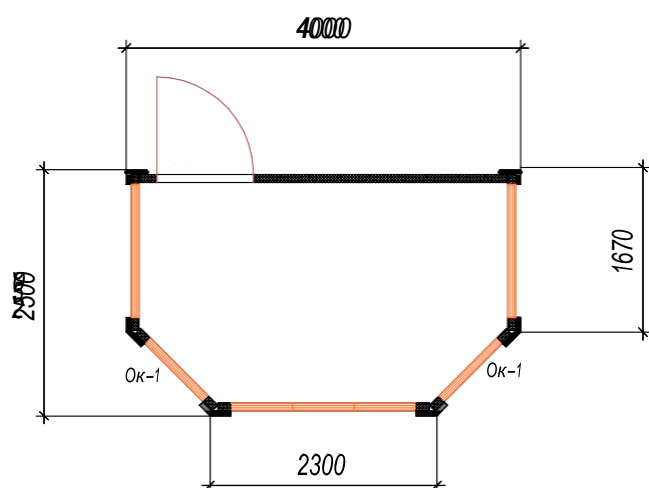

## VARIETY OF APPLICATION

Container units allow to build the pavilion, cafe, car service, or any other building quickly for any business needs.

# OBJECTS OF SPECIAL PURPOSE



## EXAMPLE OF LAYOUT

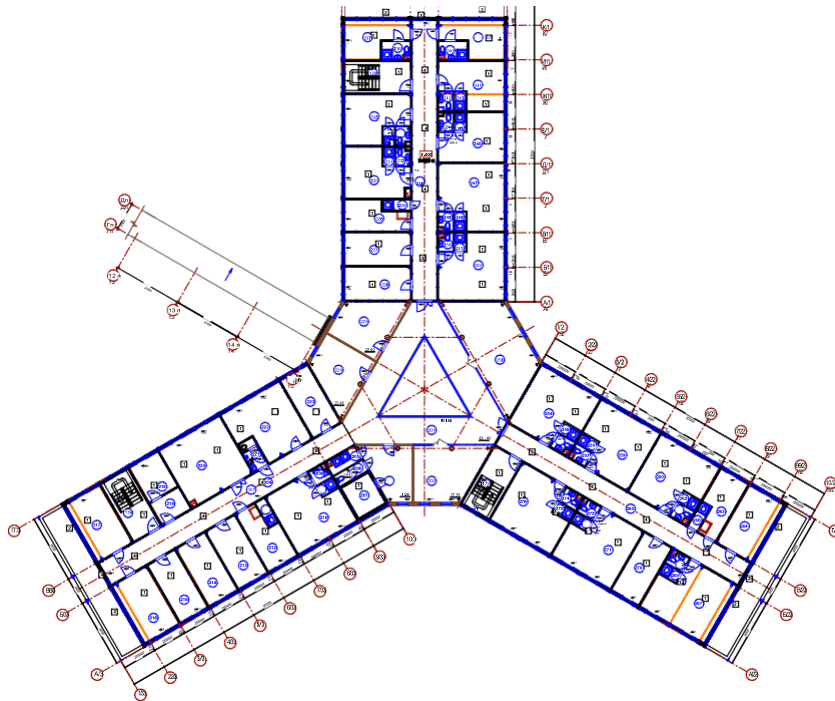

### MEETS ALL STANDARDS AND NORMATIVE DOCUMENTS

Container unit is made of high quality materials and has all the necessary certificates. This allows to construct buildings for special objects.

# TECHNICAL CHARACTERISTICS AND DIMENSIONS

CONTAINER UNIT 20'			
		Thermal insulation 80 mm	
Weight when assembled		2 070 kg	
Transportation weight		2 100 kg	
Total useful area		12,92 m <sup>2</sup>	
Total premise volume		29,85 m <sup>3</sup>	
	External dimensions		Internal dimensions
	Assembled	Transportation	Assembled
		Thermal insulation 80 mm	Thermal insulation 80 mm
Length	6 055 mm	6 055 mm	5 835 mm
Width	2 435 mm	2 435 mm	2 215 mm
Height	2 591 mm	865 mm	2 311 mm

## SIZES

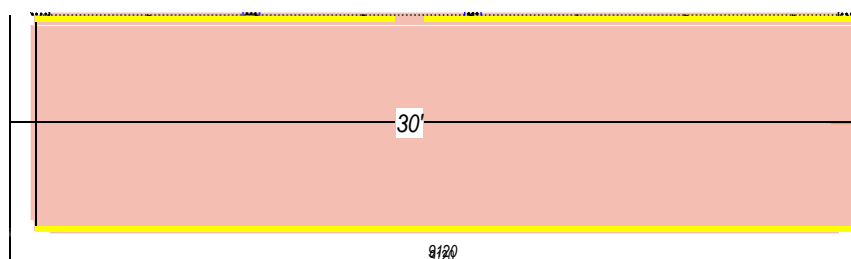
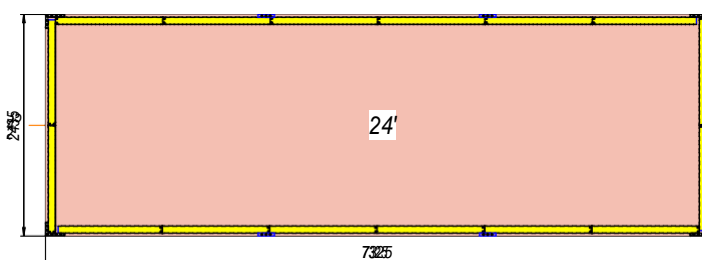
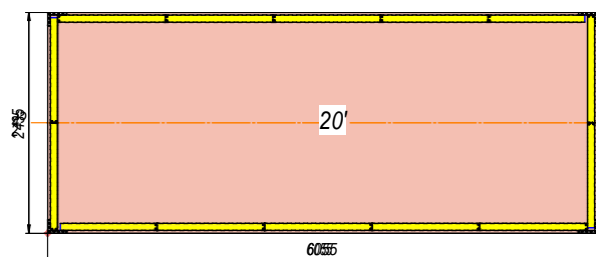
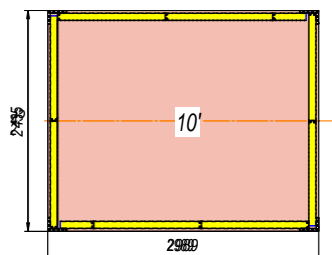
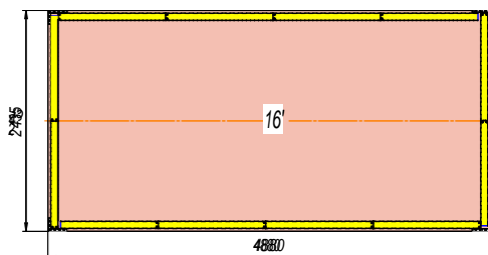



# SANDWICH PANELS

Roof panel

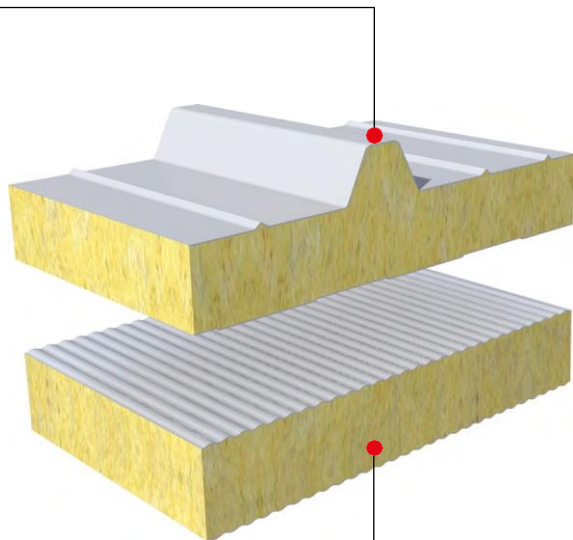

Wall panel

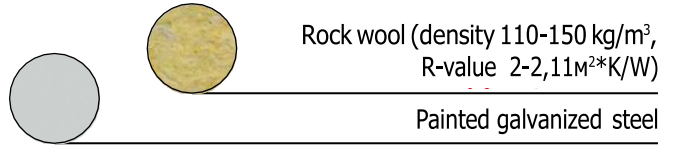

"Z-LOCK" PROVIDES A RELIABLE AND STRONG CONNECTION

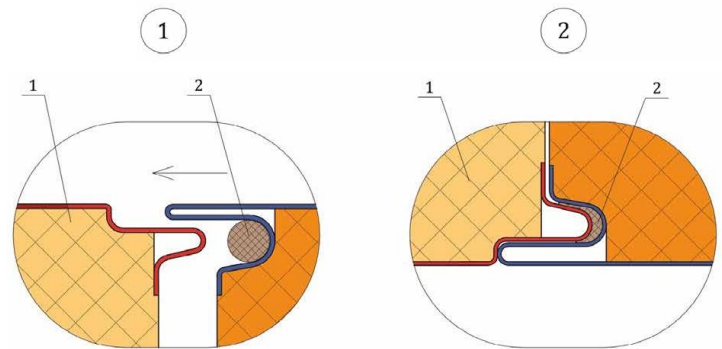
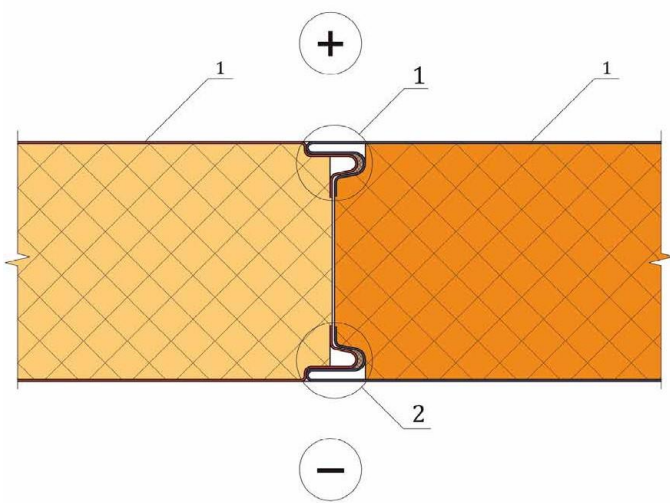

1. Wall panel
2. Sealant for outdoor work

## COLORS

RAL 1014		RAL 3005		RAL 6002		RAL 9002	
RAL 1015		RAL 3009		RAL 6005		RAL 9003	
RAL 1018		RAL 3020		RAL 7004		RAL 9006	
RAL 2004		RAL 5002		RAL 7024		RAL 9010	
RAL 3003		RAL 5005		RAL 8017			

# PROFILING OF ROOF SANDVICH PANEL

## PROFILING OF OUTSIDE

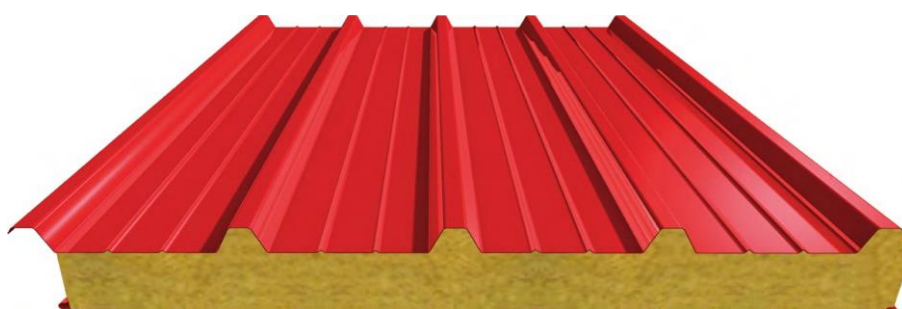
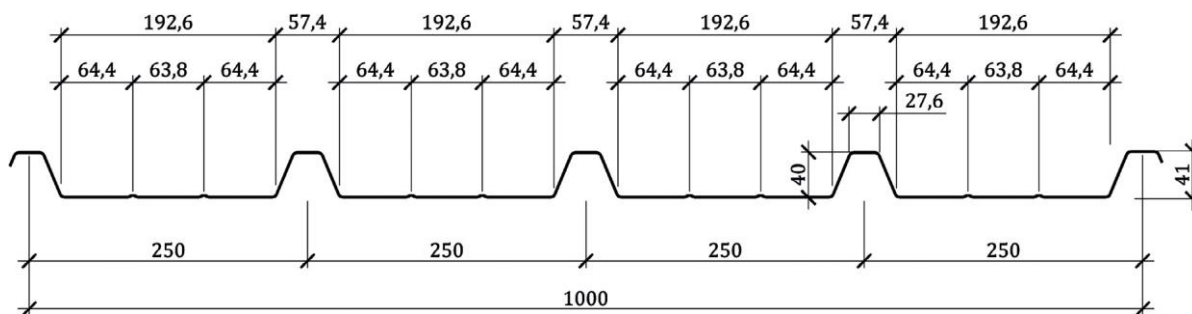

## PROFILING OF INSIDE

Microwave

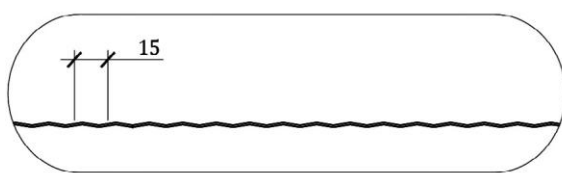

V-профиль

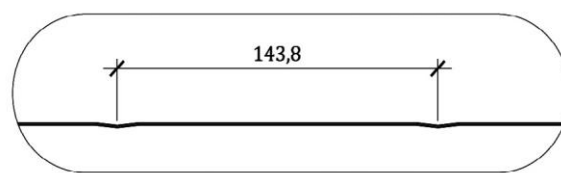

Trapeze

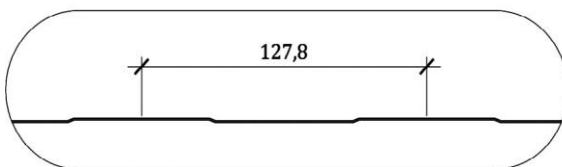

Smooth

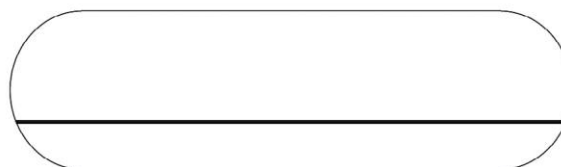

# PROFILING OF WALL SANDVICH PANEL

## PROFILING OF BOTH SIDES

V-profile

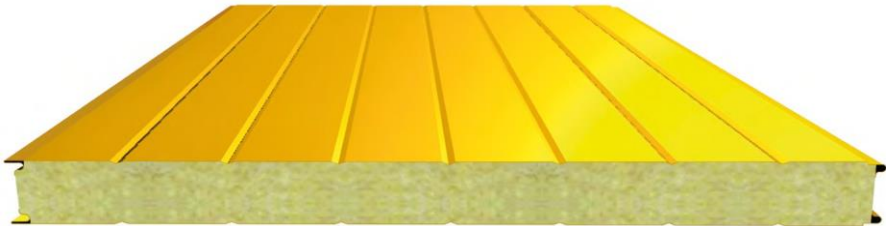

Trapeze

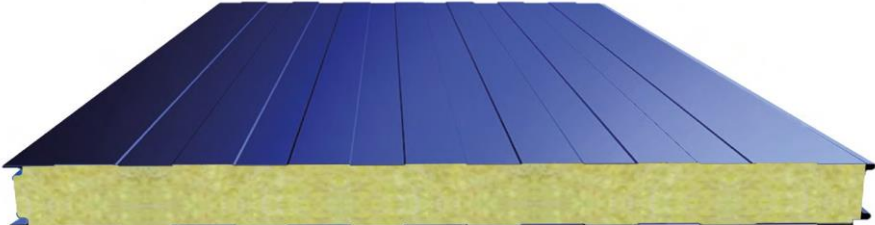

Microwave

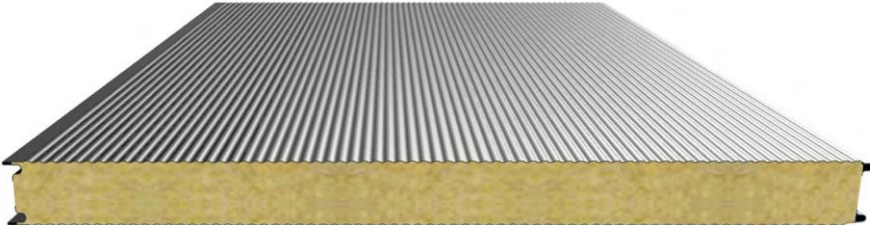

Smooth



# EXAMPLE OF AMENITY

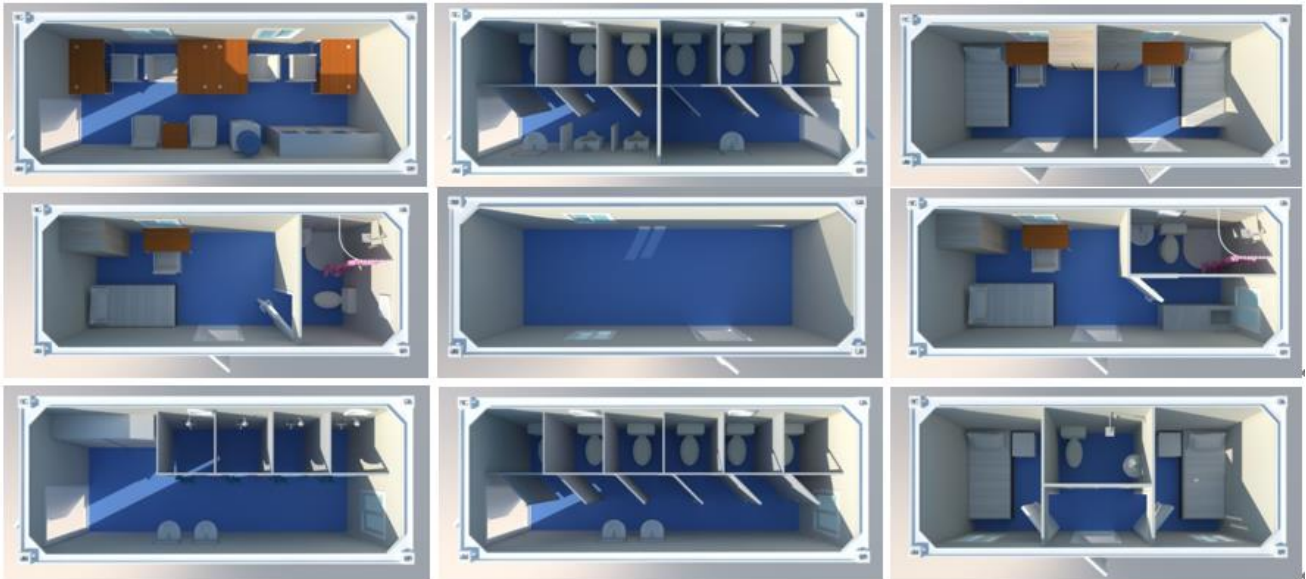

Accommodation flat pack container  
Can be 100% customized

Example of inside layouts

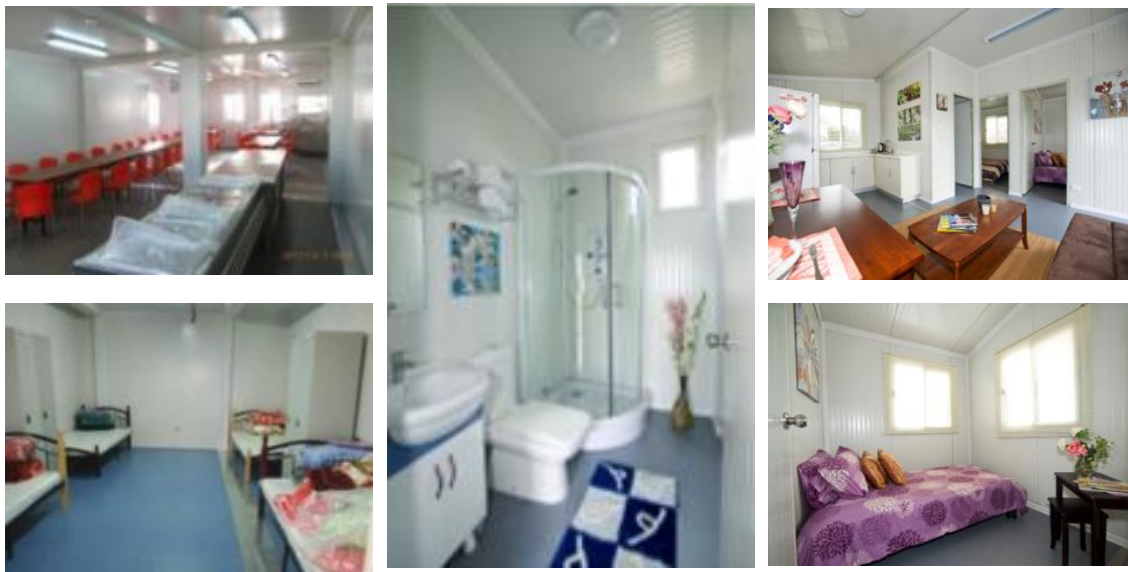

# CONTACTS

## CHINA



### Suzhou Office (Administration)

Baodai xi road 5188, Xukou town  
Suzhou, China, code: 215464

### Shanghai Office (Showroom)

N.1030 Yan an Xi Road, Building 16, Room 704  
Shanghai, China, code: 200000

### Warehouse Office

Hongzong Branch road No.668, Ming hang District,  
Shanghai, China, code: 20110

 +86 (21) 525 200 31 (From overseas)  
525 20031 (From China)

 [info@ace-international.net](mailto:info@ace-international.net)

## AUSTRALIA



### ACE Safety PTY LTD

6/10 Ocean Street,  
NSW 2026, Sydney, Australia

 +61 438 357 260

## ACE International Southeast Asia (Philippines)



ENERCON Ventures Inc.  
Mr. Rizaldy Lanon

 +63 917 839 6485

 [info-sea@ace-international.net](mailto:info-sea@ace-international.net)